

WORKIO™

DIGITAL IMAGING SYSTEMS

7000/6000

Panasonic

DP-7000

DP-6000

- High-speed 70/60 ppm copying/printing
- High-speed 75 ppm image scanner with duplex ADF
- 600 x 600 dpi resolution with image enhancement
- Maximum paper capacity of 6,300 sheets
- Multi-protocol, multi-network connectivity



Digital
Convergence
Gets Real

WORKiO – Where Paper and Digital Converge

Office digitization has transformed the workplace — saving time and making it possible to manage more data more efficiently. But has it really made your job any easier? After all, now there's more equipment to deal with than ever — photocopiers, faxes, printers, scanners, computers... Not to mention the daily deluge of e-mail and fax-based communications you have to sift through and organize. With so many PC-based digital files and paper documents piling up, managing your document workflow is getting tougher and tougher.

So wouldn't it be great if there was a way to manage all of your document transactions with a single, standardized system? A system that would accept both digital and paper-based analog inputs and output them in whatever format required? A system that finally does what digitization has promised all along — make your job easier?

Happily, there is such a system.

WORKiO — The Digital Imaging System for the next-generation office.

WORKiO is all about "**convergence**". It's about bringing together all the different media and formats used today for document processing, distribution and communications and consolidating them in a single unit so you can reduce your equipment overhead and free up valuable office space. It's about integrating your document workflow into a single, seamless process so you can work more quickly and efficiently. And it's about a breakthrough in design that makes all of this possible without sacrificing performance or ease of use. WORKiO is the one-stop control center for all documents — whether they're paper or digital.

Better yet, WORKiO is designed to be as flexible and adaptable as you are. Its modular design lets you choose the options you need, configuring exactly the system that best suits your needs today, and leaving you with the opportunity to upgrade as your requirements grow.

With WORKiO, you get all the power of big business office systems in a single, compact, easy-to-use unit that easily handles all your document processing requirements. Whether it's paper documents or PC based digital data — WORKiO does everything **from input to output**. As the hub of the networked office, WORKiO keeps busy instead of keeping you busy.

WORKiO from Panasonic — True convergence. Total integration.



WORKiO
Works for you!

Productivity, Durability & Reliability You Can Rely On.

The Heavy-Duty WORKiO DP-7000 And WORKiO DP-6000 Are The Ultimate Business Document Solution.

With their blazing speed and outstanding quality, the new WORKiO DP-7000 and WORKiO DP-6000 Digital Imaging Systems are hands down the most evolved multi-function products on the planet. As the flagship models of Panasonic's new-generation WORKiO series, the WORKiO DP-7000 and the WORKiO DP-6000 are built to handle the demands of even the busiest departments and workgroups. Boasting a heavy-duty, low-maintenance design that keeps downtime to a minimum, these rugged workhorses can copy or print at a phenomenal 70/60 pages a minute. Scanning capabilities are equally impressive with speeds up to 75 pages per minute. So no matter how big the job or how tight the schedule, the WORKiO DP-7000 and the WORKiO DP-6000 can take care of it for you. And since both models also feature full network connectivity, they can easily be integrated in your existing local area network, ensuring that document management and processing requirements throughout the office are handled with maximum efficiency and superior productivity.

The WORKiO DP-7000 and the WORKiO DP-6000 — the new-generation digital document processor that offers the ultimate in productivity, durability and reliability.



WORKiO[™]
DIGITAL IMAGING SYSTEMS
7000/6000

High-Productivity Digital Copier

— Speed, Volume, And Durability

High-Speed Copying Capability

With the ability to pump out up to 70 standard letter-size (Portrait) copies per minute (60 with DP-6000), the WORKiO DP-7000 and the WORKiO DP-6000 bring real document processing power to your office. Thanks to the Dual-Spot Laser Beam design, simultaneous dual-line image tracing is made possible, resulting in higher copying capability. With a first copy time of 2.7 seconds, the WORKiO DP-7000 and the WORKiO DP-6000 never keep you waiting.

Continuous Duplex Copying

Another big boost for office productivity and efficient paper usage is Continuous Duplex Copying capability. Thanks to the constant-velocity design duplex ADF unit and the “tray-less” automatic duplex unit design, maximum 70/60 pages-per-minute high-speed copying is possible even in Continuous Copy mode.

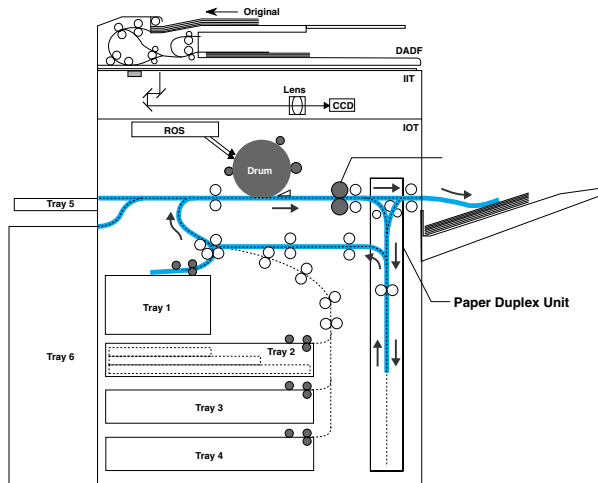

Convenient Copy Features

Flexibility is a cornerstone of Panasonic design, and the WORKiO DP-7000 and the WORKiO DP-6000 are no different. A variety of convenient functions are provided to make sure you have the choices you need for any application. With **N-in-1 Copy**, you can make 2, 4 or 8 originals into a single copy with a variety of layouts to choose from. **Electronic Sorting** capability comes standard, providing simple finishing capabilities, while the optional Offset Catch Tray adds the ability to offset-sort copies for enhanced productivity. **Proof Copy** outputs a sample copy so you can confirm finished copy results before you start, helping you avoid costly mistakes in volume copying.

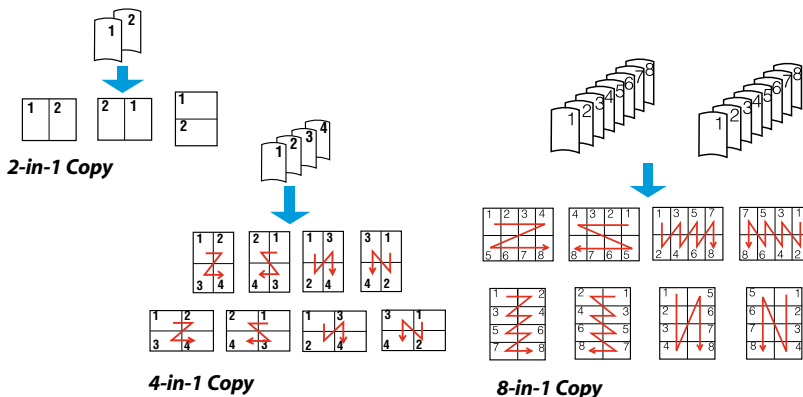

6,300-Sheet Paper Capacity

Still think you need a professional copy shop for those really big jobs? Think again. With the optional large-capacity paper tray, you can load up to 6300 sheets of various sizes into the WORKiO DP-7000 and the WORKiO DP-6000, ensuring smooth output and maximum efficiency even with high-volume document processing.



High Quality and High Speed Image Output

— Superior Quality Assured Even With High-Speed Output



High-Resolution 600 dpi Quality

The WORKiO DP-7000 and WORKiO DP-6000 maintain super-quality 600 dpi resolution, in spite of their incredibly fast copying time. Edges of text characters are reproduced clearly with full 600 dpi resolution while non-edge sections are efficiently reproduced in solid black with 200 dpi resolution. The resulting copies feature crisp, legible text with no blurring of small characters, even in multi-generation copies.

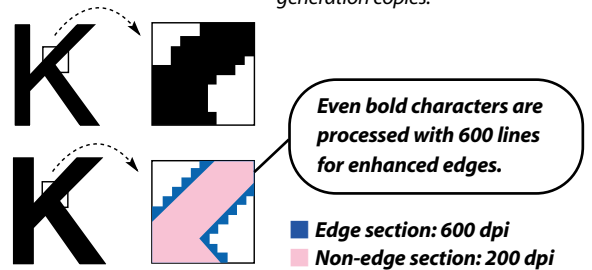

256-Level Halftone Reproduction

Text and images are detected and processed separately, enabling photographs and gradations to be reproduced with higher fidelity and smooth, perfectly blended halftones. With 256-level halftone capability, even originals that include both photographs and text on the same page can be reproduced accurately and legibly.

Extra Durability & Eco-Friendly

— Enjoy Peace Of Mind With Safe, Reliable, Trouble-Free Performance

Superior Durability & Reliability

To make sure you don't run into trouble right in the middle of a major high-volume, high-priority job, the WORKiO DP-7000 and the WORKiO DP-6000 have been built to the most rigorous standards, offering the durability and reliability you need for long-term, continuous operation.

Environment-Friendly Design

A low-noise, low-ozone emission design keeps your office environment quiet and clean, while Energy Star compliance maintains power consumption efficiency at only 6 watts in Sleep mode.

Comprehensive User Interface

Using the WORKiO DP-7000 and the WORKiO DP-6000 oversized touch-sensitive LCD screen, even complicated tasks can be performed easily via the easy-to-understand pictorial graphics and icons. For added convenience, controls are user-customizable, allowing you to re-assign frequently used functions to the upper layer for quicker access.



* As an ENERGY STAR® Partner, Panasonic has determined that this product meets the ENERGY STAR® Guidelines for energy efficiency.

High-Reliability Network Printer/Scanner

— A Document Processing Hub For Your Entire Office

High-Speed Laser Printer

With an optional parallel port interface mounted on the copier and the printer driver installed on a PC, the WORKiO DP-7000 or the WORKiO DP-6000 and the PC can be directly connected, delivering up to 70/60 ppm (Letter portrait) printing capability.

2400 dpi Resolution with Image Enhancement

Thanks to newly-developed image enhancement technology, ultra-high resolution equivalent to 2400 dpi is now possible. Even with large-sized characters, jagged slanted and curved lines are evened out for crisper images. Plus, the 256-level halftone reproduction can reproduce clearer photographs and smoother gradations.

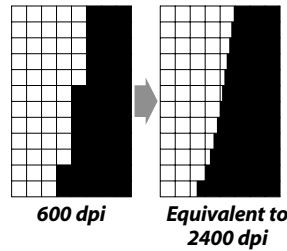

Genuine PostScript® 3™ Compatible

Fully compatible with the Adobe® PostScript® 3™ page description language, the WORKiO DP-7000 and the WORKiO DP-6000 assure high-quality, industry-standard printouts. You can install commercially available font sets (such as Adobe® Type I) for further versatile printing capability.

*PostScript® printing requires printer/scanner option.

Print Job Spooling

Thanks to a large-capacity built-in hard disk and high-capacity memory, up to 3 print jobs (up to 700 pages per job) can be spooled onto the WORKiO DP-7000 or WORKiO DP-6000 itself, assuring fast, efficient processing of multiple print jobs.

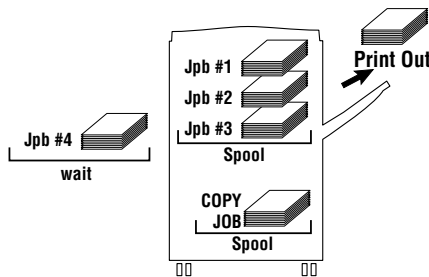

Multi-Protocol & Multi-Network Design

A 10Base-T/100Base-TX Ethernet network interface is provided as standard, with the printer option allowing you to use the WORKiO DP-7000 or the WORKiO DP-6000 as a network printer right out of the box. With their multi-protocol/multi-network design, the WORKiO DP-7000 or the WORKiO DP-6000 can accommodate any PC on a LAN driven by AppleTalk, IPX/SPX (NetWare) or TCP/IP, while its concurrent multi-access design ensures accurate data processing every time.

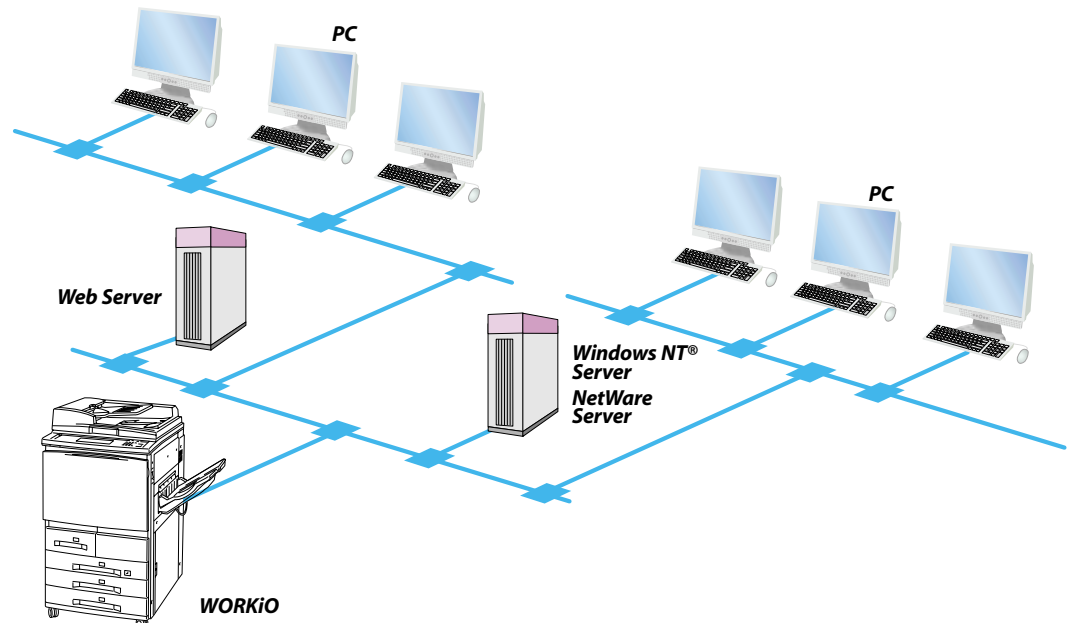

Versatile Network Printing

With IPP (Internet Printing Protocol) capability, you can print out a document on a remotely installed WORKiO DP-7000 or WORKiO DP-6000 by transmitting the print command via the Internet. The SMB (Server Message Block) compatibility allows peer-to-peer connection between a Windows® PC and the WORKiO DP-7000 or WORKiO 6000 without assigning a specified IP address (SMB over NetBEUI). This is convenient for printing a document directly from your client PC without routing through the server.

High-Speed Network Scanning

With a network connection, the scanned data can be transferred to any client PC on the LAN via TCP/IP protocol. It's a great way to share documents and much more efficient than printing out copies for everyone.

High-speed network scanning and transfer is possible at 75 ipm via 10Base-T/100Base-TX connection. Once stored in the WORKiO DP-7000's or the WORKiO DP-6000's built-in HDD, scanned document data can be zipped over to any client PC on your LAN via TCP/IP protocol. It's a great way to share documents and much more efficient than printing out copies for everyone.

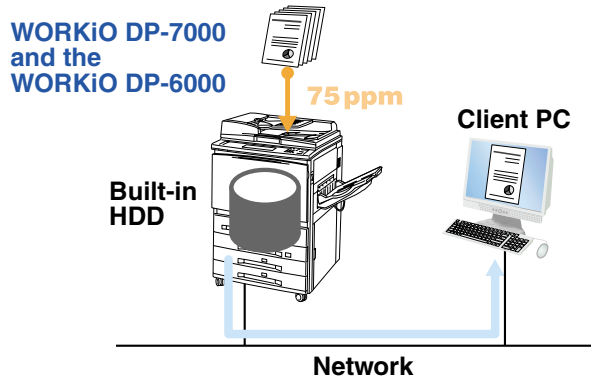

System Configuration & Options

— Capacity and Capabilities Expandable As You Need

Versatile, Expandable System Design

No matter what your requirements, the WORKiO DP-7000 and the WORKiO DP-6000 can be configured to handle them. For high-volume copying/printing requirements, add the optional High-Capacity Feeder. This expands paper supply capacity to a very substantial 6,300 sheets. If you want to produce documents ready to be packaged in a binder or presentation cover, simply add the Punching Finisher. With the Punching Finisher added, you can turn the entire production of a document into a single batch process — from printing the original PC file and making multiple copies to sorting and punch finishing, the entire sequence of operations requires only a single command from your PC. It's like making a book at the touch of a button. Plus, with the standard-equipped Duplex ADF Unit, your productivity is high right from the start.



Standard Configuration

Standard WORKiO DP-7000 and WORKiO DP-6000 Digital Copier/Printer/Scanner package for departmental corporate office users who require high-volume copying, printing and scanning document processing.

* Offset Catch Tray and Printer/Scanner are optional.

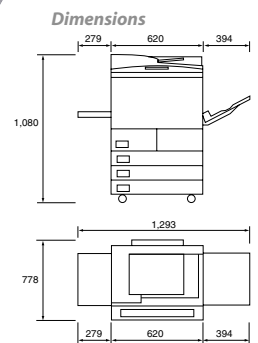

Extended Configuration

The WORKiO DP-7000 and the WORKiO DP-6000 Digital Copier/Printer/Scanner package with Punching Finisher option for users who require finishing capability in addition to high-volume document processing.

* Printer/Scanner and Finisher with Puncher are optional.

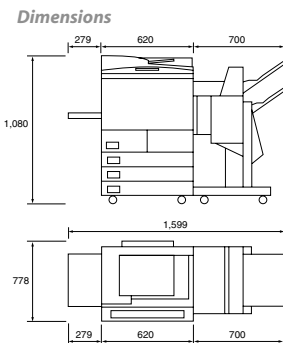

Ultimate Configuration

The WORKiO DP-7000 and the WORKiO DP-6000 Digital Copier/Printer/Scanner, plus Punching Finisher and High-Capacity Feeder (max. 6,300 sheets paper supply available) for users who require extra high-volume document processing with finished results.

* Printer/Scanner, Finisher with Puncher and High-Capacity Feeder are optional.

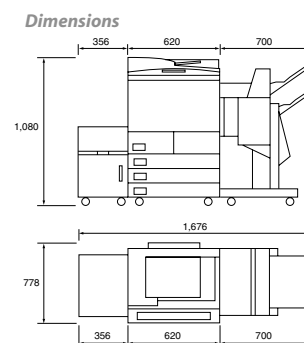

DP-7000/6000 Specifications

General/Digital PPC	
Type	Console Type
Copy / Print Process	Laser / Electrostatic photographic method
Warm-up Time	180 seconds
First Copy Time	2.7 seconds
Resolution	Scanning: 600 x 600 dpi Printing: 600 x 600 dpi
Gray Scale	256 steps
Multi Copy Speed	DP-7000 70 copies per minute DP-6000 60 copies per minute
Maximum Original Size	11" x 17"
Maximum Copy Size	11" x 17"
Copy Size	Ledger, Legal, Letter, Invoice
Copy Ratio	Enlargement (fixed) 200%, 154%, 129% Reduction (fixed) 78%, 64%, 50%
Zoom (variable)	25 ~ 400% (in 1% increments)
Duplex Automatic Document Feeder	50 sheets (20 lb. paper)
Paper Feed	Max.: 6300 sheets Standard: 1000 sheets x 1 + 550-sheet paper tray x 3 + 50 sheet bypass Optional: High-Capacity Feeder 3600 sheets
Power Requirements	120 VAC, 50/60 Hz
Power Consumption	Max. : Less than 1.4 kW Warm-up: 1019 W Idle: 263 W Energy Saver: 206 W Sleep Mode: Approx. 6 W
Dimensions (H x W x D)	24.4" x 30.6" x 42.5**7 (620 x 778 x 1080 mm)
Weight (Excluding optional equipment)	Approx. 408 lbs**7 (185 kg)

Printer (Optional)	
Printing Speed	DP-7000 70 pages per minute DP-6000 60 pages per minute
Printing Resolution	600 dpi, 2400 dpi with edge enhancement
Interface	100Base-TX/10Base-T Ethernet, Bi-directional parallel
Operating System	Windows NT® 4.0, Windows® 95/98/Me/2000, Mac OS 8.x/9.x
Page Description Language	PCL6 PostScript® 3™ (Option)
Protocol	TCP/IP, IPX/SPX, EtherTalk
Page Memory Capacity	Standard: 32 MB, Max.: 96 MB
Hard Disk Drive (Option)	12 GB

Scanner (Optional)	
Scan Size	Max. 11" x 17"
Scan Speed	75 pages per minute
Scanning Resolution	200/300/400/600 dpi
Interface	TWAIN
Protocol	TCP/IP
Operating System	Windows NT® 4.0, Windows® 95/98/Me/2000, Mac OS 8.x/9.x

High-Capacity Feeder (Optional)	
Paper Capacity	3600 sheets (20 lb. paper)
Paper Size	Letter
Power Requirements	Supplied from the main unit
Power Consumption	21 W
Dimensions (W x D x H)	14.0" x 25.7" x 22.8" (356 x 652 x 580 mm)
Weight	86.0 lbs (39 kg)

Finisher (Optional)	
Stapling	50 sheets (less than 80 g/m ²)
Hole Punching	3 holes
Power Requirements	Supplied from the main unit
Power Consumption	72 W
Dimensions (W x D x H)	27.6" x 25.6" x 43.3" (700 x 650 x 1100 mm)
Weight	121.3 lbs (55 kg)

Windows and Windows NT are registered trademarks of Microsoft Corporation.
 Adobe, PostScript and PostScript logo are trademarks of Adobe Systems, Inc.
 PCL is a registered trademark of Hewlett-Packard.
 WORKIO is a registered trademark of Matsushita Graphic Communication Systems, Inc.
 ENERGY STAR is a U.S. registered mark.
 All other brand or product names are the property of their respective holders.

Design and specifications are subject to change without notice.

ISO 9001 Quality Management System

Every aspect of Matsushita Graphic Communication Systems, Inc. (MGCS)'s office information equipment business processes, from manufacturing to marketing, conforms to ISO (International Organization for Standardization) 9001 quality management system standard.

Design, development, manufacture, installation, repair and maintenance of office information equipment, their associated devices and consumables.



In addition, MGCS's plants outside Japan have acquired ISO 9002 certification.

Panasonic®

Panasonic Document Imaging Company
 A Business Unit of Matsushita Electric Corporation of America
 Two Panasonic Way, Secaucus, NJ 07094
 For a local dealer, please call 1-800-742-8086.
<http://www.panasonic.com/office>